

85783 Remote Dispensing, Single Pouch System

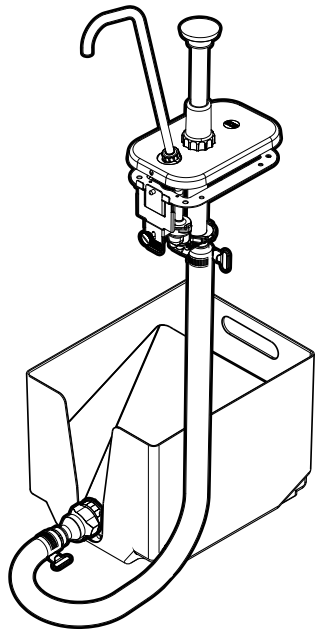

Complete View for Reference

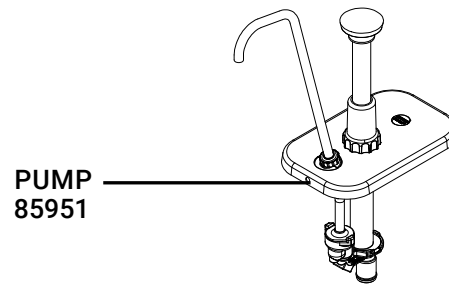

PUMP
85951

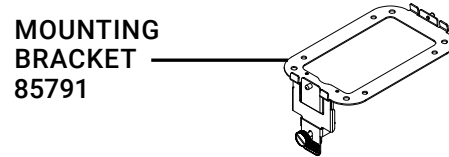

MOUNTING
BRACKET
85791

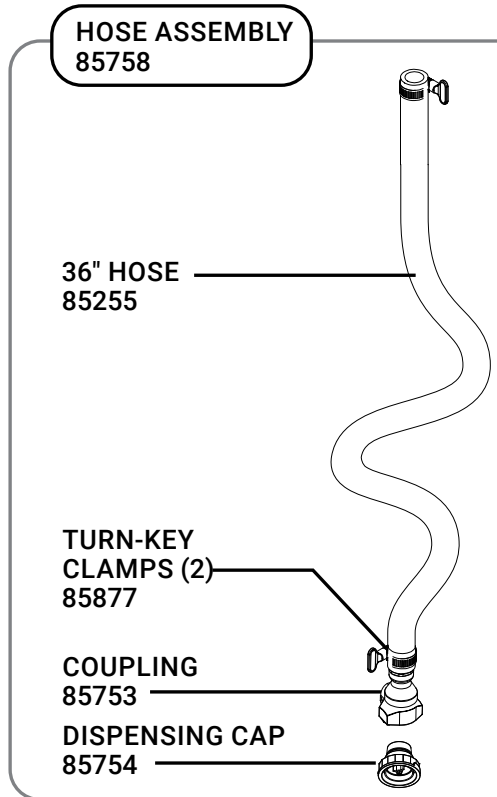

HOSE ASSEMBLY
85758

36" HOSE
85255

TURN-KEY
CLAMPS (2)
85877

COUPLING
85753

DISPENSING CAP
85754

16MM ADAPTER
85264

52" BRUSH
85206

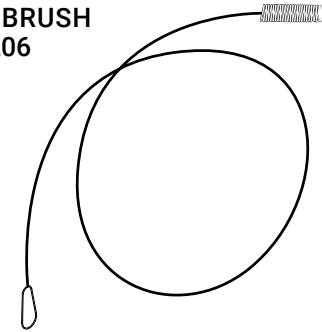

EVACUATION
PLATE
07814

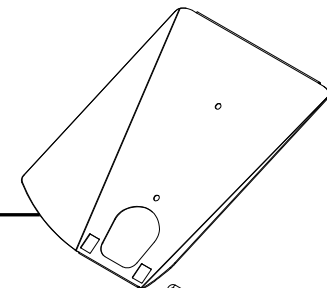

TORSION
SPRING
07813

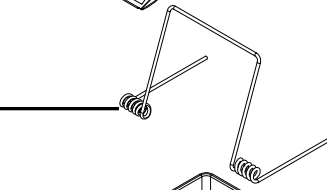

POUCH
SUPPORT
07811

